

Before start ,please carefully read the explanations!

# Sport jet Voyager 128"



**Length:** 3253mm/128 in  
**Wing Span:** 2790mm/110 in  
**Turbine:** 18--26kg  
**Radio:** Min. 7 Servos required  
**C.G:** 280mm from the leading edge of wing root.

## INSTRUCTION MANUAL



### SAFETY PRECAUTIONS

This R/C airplane is not a toy!

(The people under 18 years old is forbidden from flying this model)

First-time builders should seek advice from people having building experience.If misused or abused,it can cause serious bodily injury and damage to property.

Fly only in open areas and preferably at a dedicated R/C flying site. We suggest having a qualified instructor carefully inspect your airplane before its first flight.Please carefully read and follow all instructions included with this airplane,your radio control system and any other components purchased separately.

## REQUIRED FOR OPERATION (Purchase separately!)



**CAUTION:** For details concerning the equipment listed below (size, maker, etc.), check with your hobby shop.

- 1** A minimum 6 channel radio for airplanes (with 8 servos), and dry batteries.



**CAUTION:** Only use a minimum 6 channel radio for airplanes! (No other radio may be used!)  
6 channel radio for airplane is highly recommended for this model.

12 AA-size Batteries

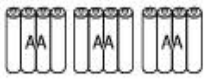

A minimum 6 channel transmitter for airplanes.



For handling the radio properly, refer to its instruction manual.

- 2** Engine and Muffler

Model Airplane Engine 18-26KG Turbine



**3**

Sponge Sheet



Gasoline tube



Fuel Filter



**4**

Glue Instant Glue



Epoxy Glue

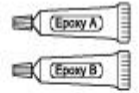

**5**

Optional electric retract set

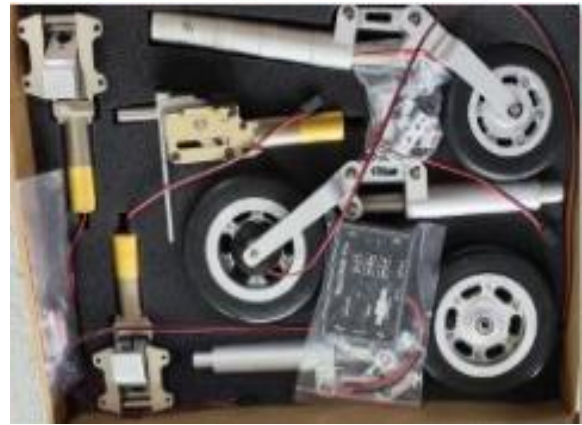

## TOOLS REQUIRED (Purchase separately!)

Sharp Hobby Knife



Phillips Screw Driver (l, m, s)



Awl



Needle Nose Pliers

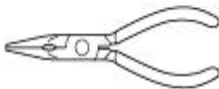

Wire Cutters



Scissors



## BEFORE YOU BEGIN

- 1 Read through the manual before you begin, so you will have an overall idea of what to do.
- 2 Check all parts. If you find any defective or missing parts, contact your local dealer.
- 3 Symbols used throughout this instruction manual, comprise:
- 4 We strongly recommend you use the thread lock for all the screws when you build your model.



Apply epoxy glue.



Drill holes with the specified diameter (2mm).



Cut off excess.



Pay close attention here!



Apply instant glue (CA glue, super glue).



Cut off shade portion.



Ensure smooth non-binding movement while assembling.



Assemble left and right sides the same way.



Must be purchased separately!













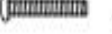



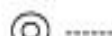

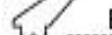
Do not overlook this Symbol!







**Warning!**











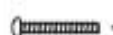

# Voyager accessories





## Servos accessories

	TP Screw (2.3x8mm)	2
	TP Screw (2.3x12mm)	10
	Socket head screw (3x12mm)	7
	Socket head screw (3x16mm)	7
	Hex screw (5x30mm)	7
	Blind nut (3mm)	14
	Bush (3x 6mm)	28
	Bush (5x12mm)	7
	Big clevis (3mm)	14
	Big horn (3mm)	14
	Push rod (3x65mm)	4
	Push rod (3x113mm)	3
	Alu wing bolt 1 (40x1200x2.5mm)	1
	Alu wing bolt 2 (14x198x1.2mm)	2
	Fuselage joiner (14x230x1.2mm)	2
	Stabilizer joiner 1 (14x216x1.5mm)	2
	Stabilizer joiner 2 (20x370x1.2mm)	2
	Vertical bolt 1 (16x245x1mm)	1
	Vertical bolt 2 (20x370x1.2mm)	1

	L bracket (25x20x3)	8
	Socket head screw (3x8mm)	16
	Mushroom head screw (3x10mm)	16
	Blind nut (3mm)	16
	Bush (3x 6mm)	16

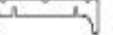
## Landing gear accessories

	TP Screw (3x14mm)	12
	Alu part for landing gear	4
	Socket head screw (3x8mm)	8
	Socket head screw (2x10mm)	3
	Blind nut (2mm)	3
	Bush (2x 6mm)	6
	Mushroom head screw (3x10mm)	4
	Blind nut (3mm)	4
	Bush (3x 6mm)	4
	Push rod (2x80mm)	2
	Plastic swing keeper	2
	Nose gear door parts	1
	Mid clevis (2mm)	1

	Fuel tank (247x110mm)	3
	Fuel tank plywood (245x28mm)	3
	Main wheel doors	2
	3mm ply sheet 1x1	1
	3mm ply tail tube frame	1

1. Apply AB glue to the slots in the ailerons, flaps and assemble the horns into them.

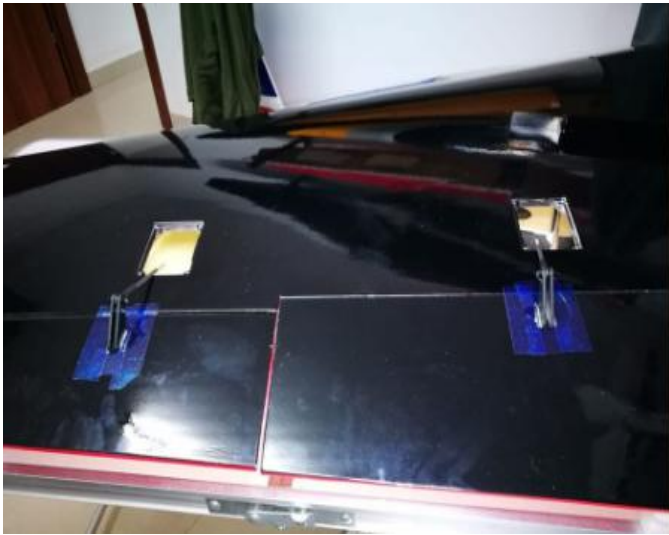

2. Assemble the servos of the wings and Connect the fiber horns to the servo arms with the linkage and locked each side with screws and locked nuts.

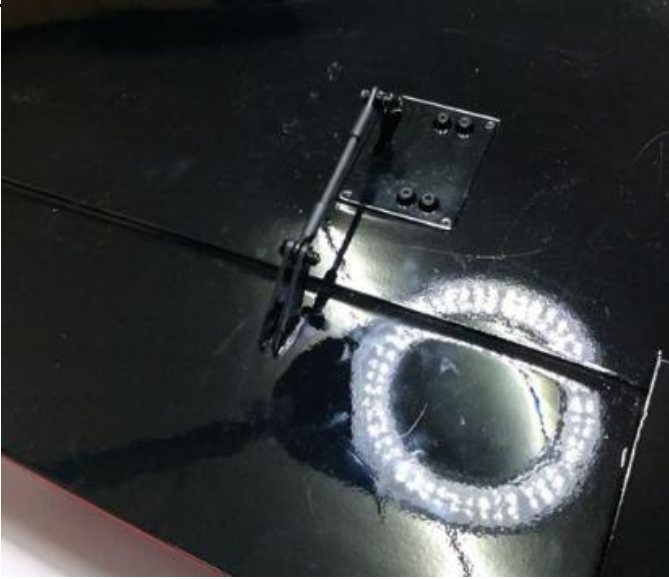

3. Test the landing gear to work and confirm the position of the hole on the gear mount .

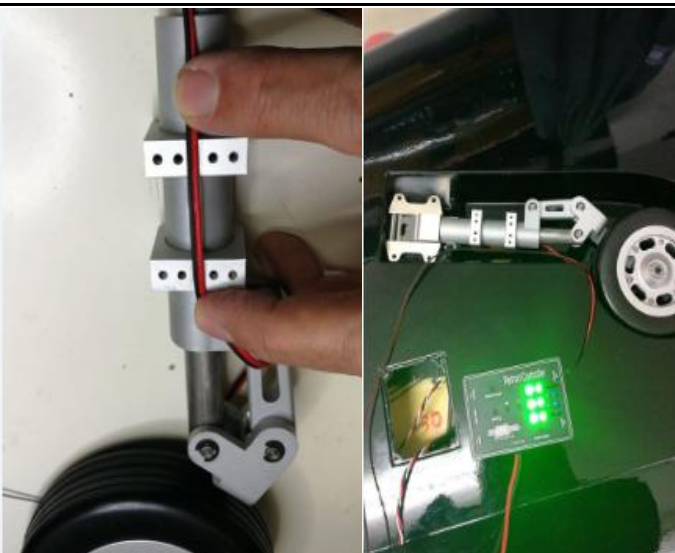

4. Assemble the landing gear to the gear mount .



5. Wing assembly ready .



6. Glue hinges to the rudder .

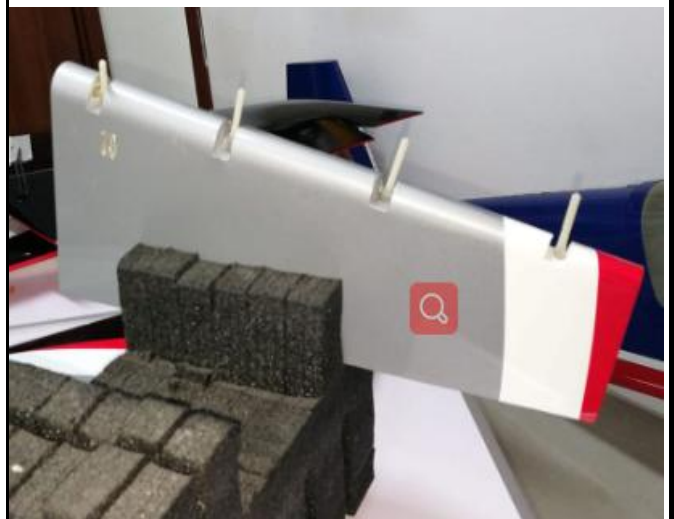

7. Glue the rudder to the vertical fin, trim a slot for the servo and assemble the servo into the vertical fin as picture .



8. Connect the servo arm and rudder horn .



9. Trim slots at appropriate position on the stabilizers and assemble the servo to the stabilizer .



10. Trim slot and glue the horn to the elevator, connect the horn and the servo arm as below .

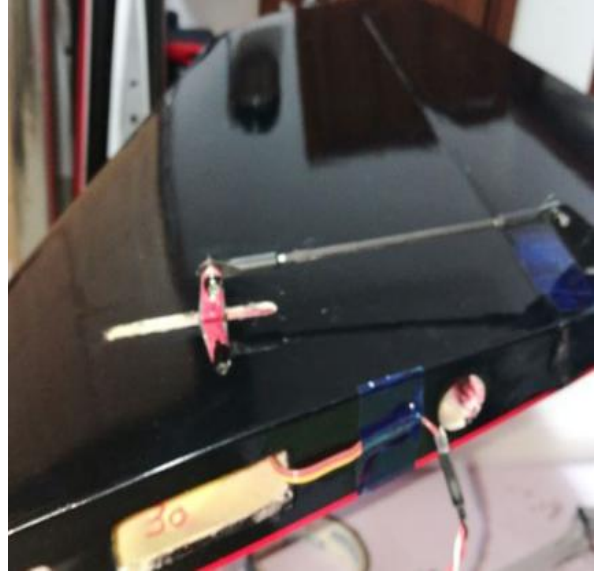

11. The work on the stabilizer are ready .



12. Assemble the nose gear .

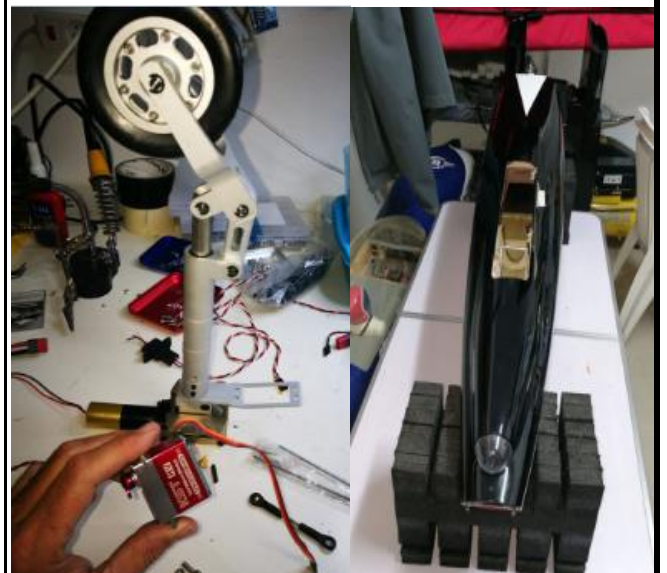

13. Assemble the nose landing gear .

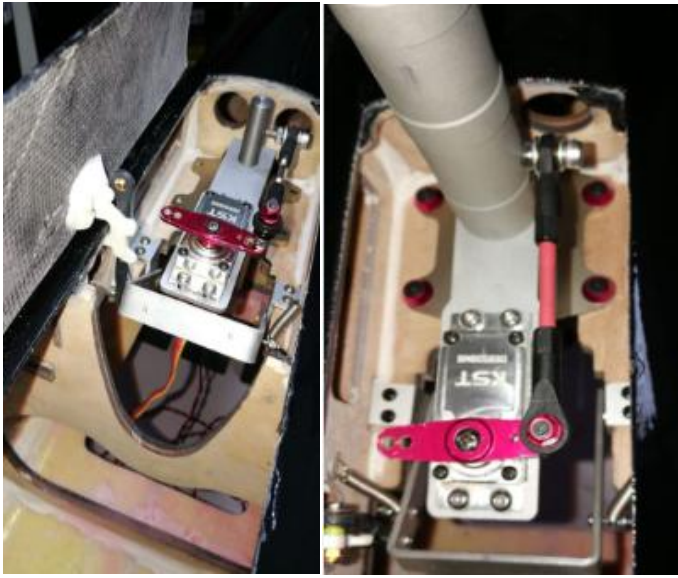

14. Nose landing gear assembly ready view from the top .

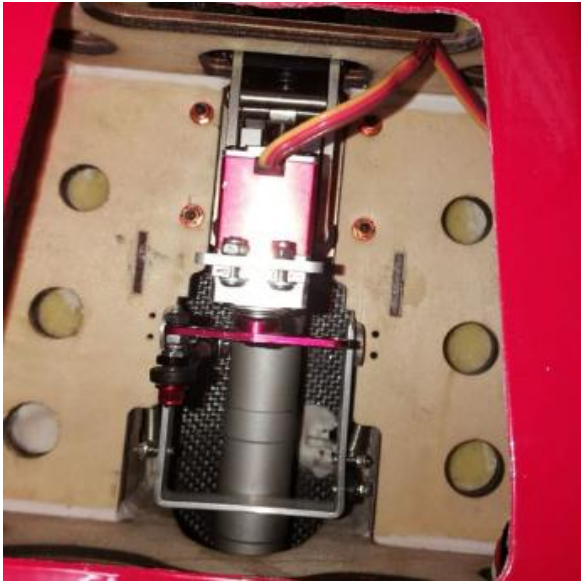

15. Prepare the fuel tank and smoke tank.



16. Assemble the tanks to the fuselage .

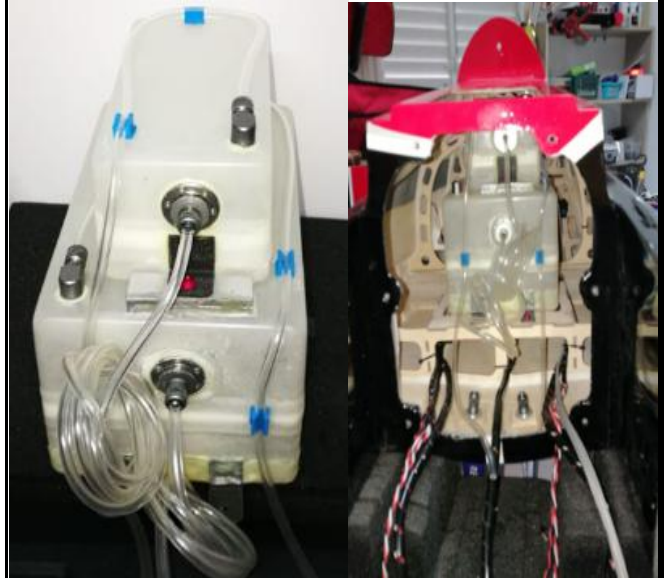

17. Assemble the engine and smoking tubes in the center fuselage.



18. Gluing the tail pipe to the tail fuselage .

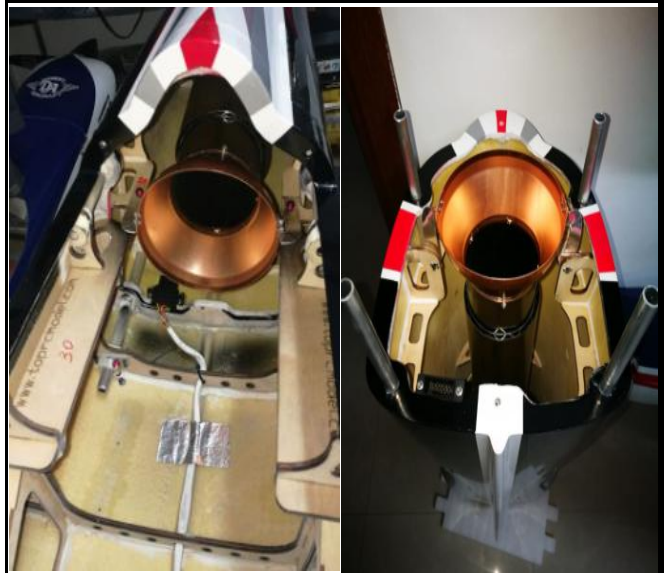

19. Fixing the tail fuselage to the center fuselage .

20. Install the battery, controller, receiver and other devices to appropriate position in the nose fuselage .

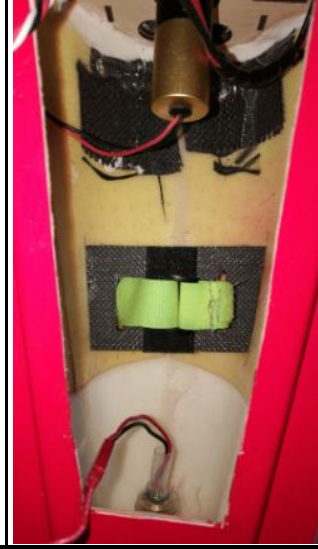

21. Assemble the canopy, wings, vertical and stabilizer to the fuselage, the pictures after everything assembly great and ready to fly .



22. Adjust the travel of each control surface to the values in the diagrams. These values fit general flight capabilities. Readjust according to your needs and flight level.

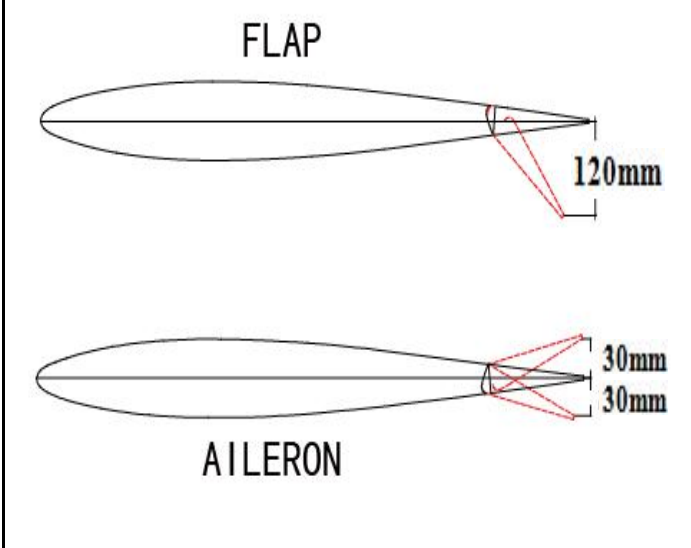

23. Adjust the travel of each control surface to the values in the diagrams. These values fit general flight capabilities. Readjust according to your needs and flight level.

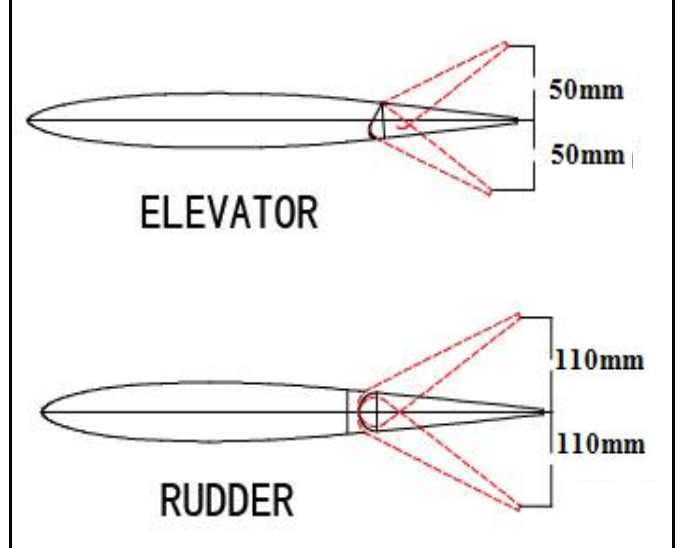

24. Check all the datas well. make sure all sections glue tightly. Otherwise if coming off during flights, you'll lose control of your airplane which leads to accidents!

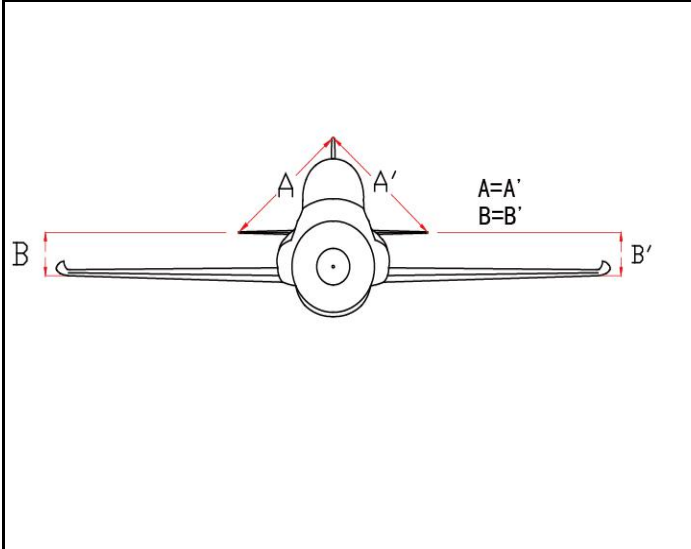

25. C.G: Never fly before checking the CG's required position. Never fly the model without well balancing.

